

PLXR2143 - KLXR2143

PORTAVALIGIE LATERALE SPECIFICO - SPECIFIC TUBULAR SIDE-CASE HOLDER - PORTE-VALISES LATÉRAUX SPÉCIFIQUE
SPEZIFISCHES STAHLROHR-SEITENTRAEGER - PORTA MALETAS LATERALES ESPECÍFICO - TRONCO LADO ESPECÍFICO

YAMAHA NIKEN 900(2019)

N°	Descrizione	Caratteristiche	Codice	Quantità
1	Telaio laterale - Side frame - Châssis latéral - Soporte lateral - Seitenrahmen - Suporte lateral	-	PLXR2143DXS PLXR2143SXS	2 (Right;Left)
2	Supporto inferiore - Lower support - Support inférieur - Soporte inferior - Untere Halterung - Suporte inferior	-	GL4190DXV GL4190SXV	2 (Right;Left)
3	Ponte - Bridge - Pont Brücke - Puente - Ponte	-	GNB2303V	1
4	Boccola - Mounting bush - Entretoise de montage Cilindro de fijación - Montagehülse - Bucha de fixação	-	Z2379	4
5	Vite - Screw Vis - Schraube Tornillo - Parafuso	TBEI M8x90	890TBEI	4
6	Vite - Screw Vis - Schraube Tornillo - Parafuso	TECF M6x20	620TECF	4
7	Rondella - Washer Rondelle - Scheibe Arandela - Arruela	Foro Ø8,5 mm / Esterno Ø20mm Sp. 2mm	820RON	4
8	Rondella spaccata - Split washer Scheibe - Rondelle fendue Arandela seccionada - Arruela Dentada	Ø8	Z1060	4
9	Rondella spaccata - Split washer Scheibe - Rondelle fendue Arandela seccionada - Arruela Dentada	Ø6	Z1063	4
10	Distanziale - Spacer Entretoise - Distanzstueck Distanciador - Espaçador	Ø20x6,2 Foro 8,5mm	C20L6,2F8,5T	4
11	Chiave Per Viti A Testa Speciale - Special Key Cle Speciale - Spezialschlüssel Llave Para Tornillos Con Cabeza Especial	-	PLXRC	1
12	Componenti Originali - Original Parts Parties Originales - Original Bauteile Componentes Originales - Componentes Originais	-	-	-
13	Particolari Inclusi nel SR2143 Components Included In The SR2143 Pièces Inclues Dans SR2143 Die Einzelnen Teile Sind Bei SR2143 Despieces Incluidos SR2143 Componentes incluidos na base SR2143	-	-	-

PLXR2143 - KLXR2143

PORTAVALIGIE LATERALE SPECIFICO - SPECIFIC TUBULAR SIDE-CASE HOLDER - PORTE-VALISES LATÉRAUX SPÉCIFIQUE
SPEZIFISCHES STAHLROHR-SEITENTRAEGER - PORTA MALETAS LATERALES ESPECÍFICO - TRONCO LADO ESPECÍFICO

YAMAHA NIKEN 900(2019)

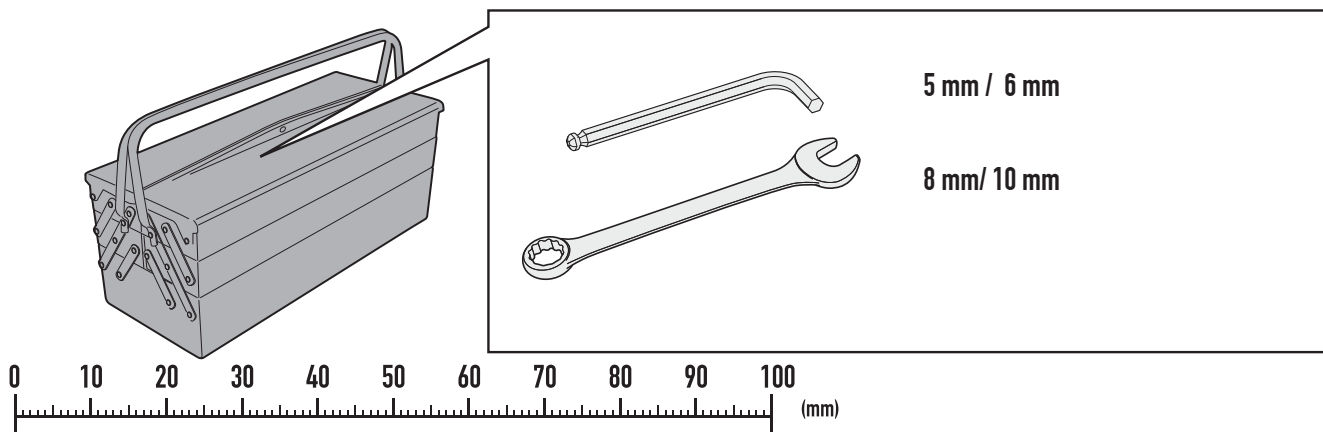
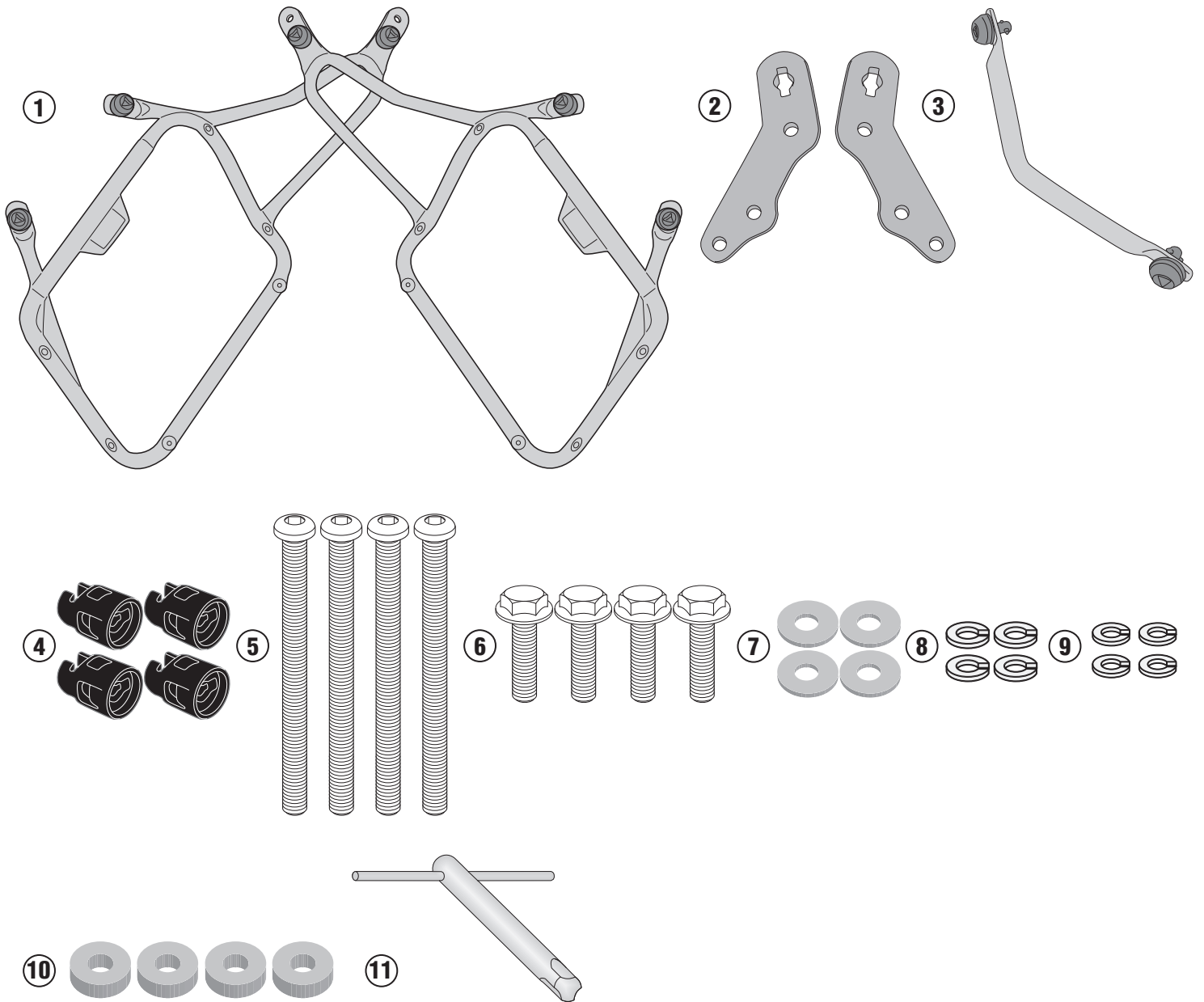

PLXR2143 - KLXR2143

PORTAVALIGIE LATERALE SPECIFICO - SPECIFIC TUBULAR SIDE-CASE HOLDER - PORTE-VALISES LATÉRAUX SPÉCIFIQUE
SPEZIFISCHES STAHLROHR-SEITENTRAEGER - PORTA MALETAS LATERALES ESPECÍFICO - TRONCO LADO ESPECÍFICO

YAMAHA NIKEN 900(2019)

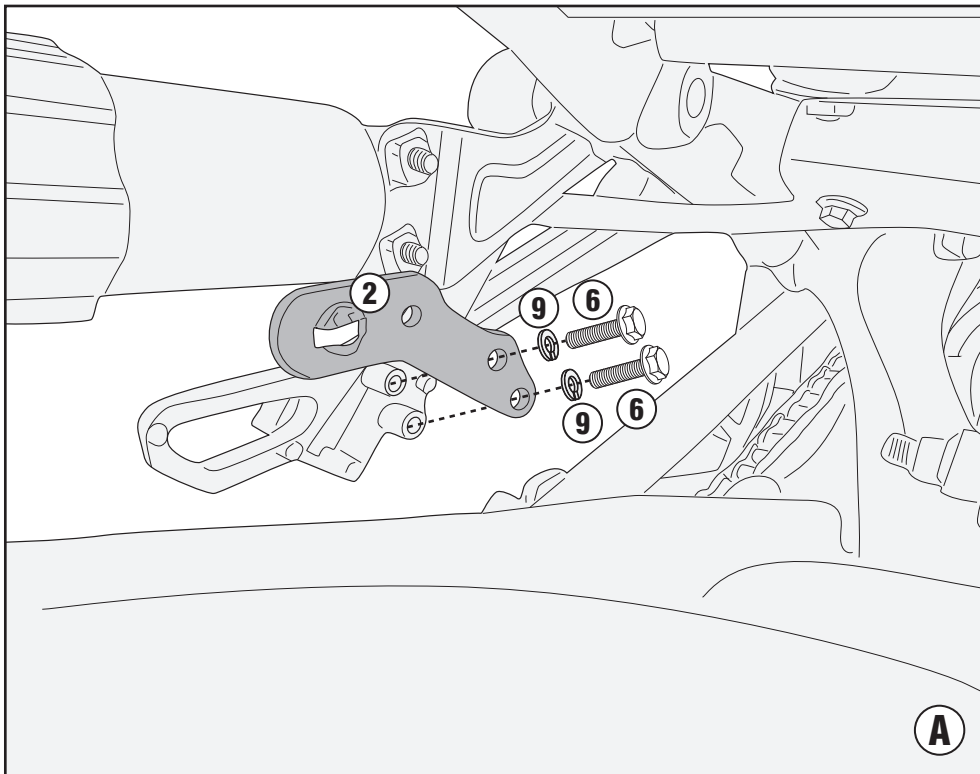
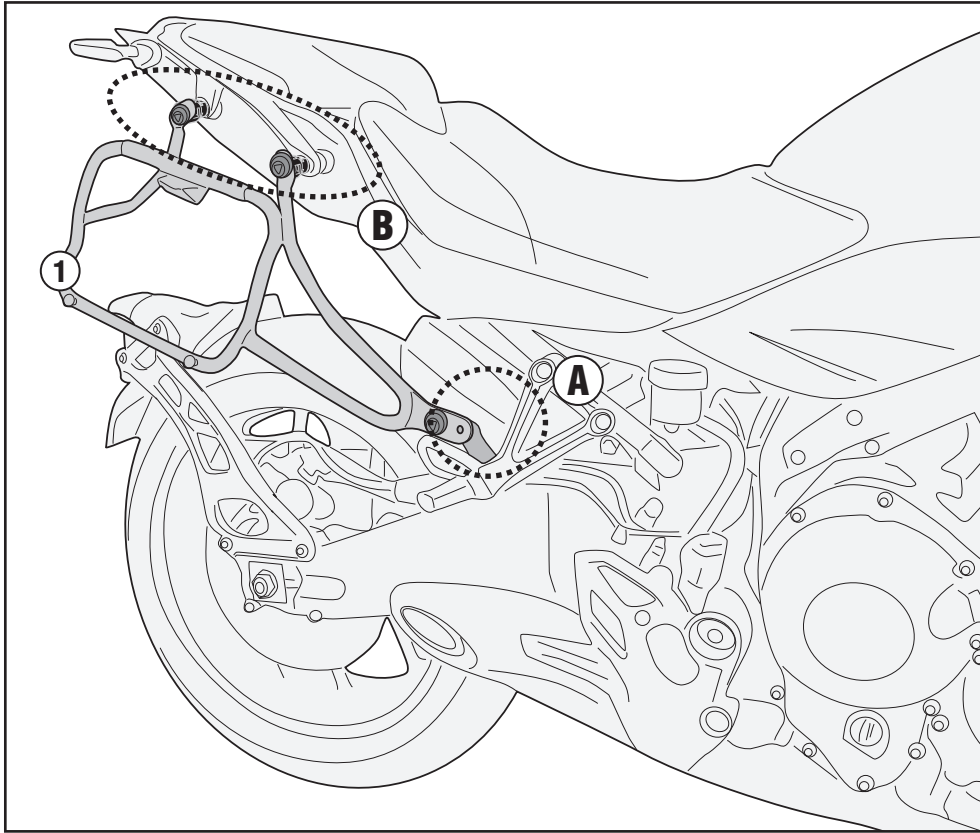

PLXR2143 - KLXR2143

PORTAVALIGIE LATERALE SPECIFICO - SPECIFIC TUBULAR SIDE-CASE HOLDER - PORTE-VALISES LATÉRAUX SPÉCIFIQUE
SPEZIFISCHES STAHLROHR-SEITENTRAEGER - PORTA MALETAS LATERALES ESPECÍFICO - TRONCO LADO ESPECÍFICO

YAMAHA NIKEN 900(2019)

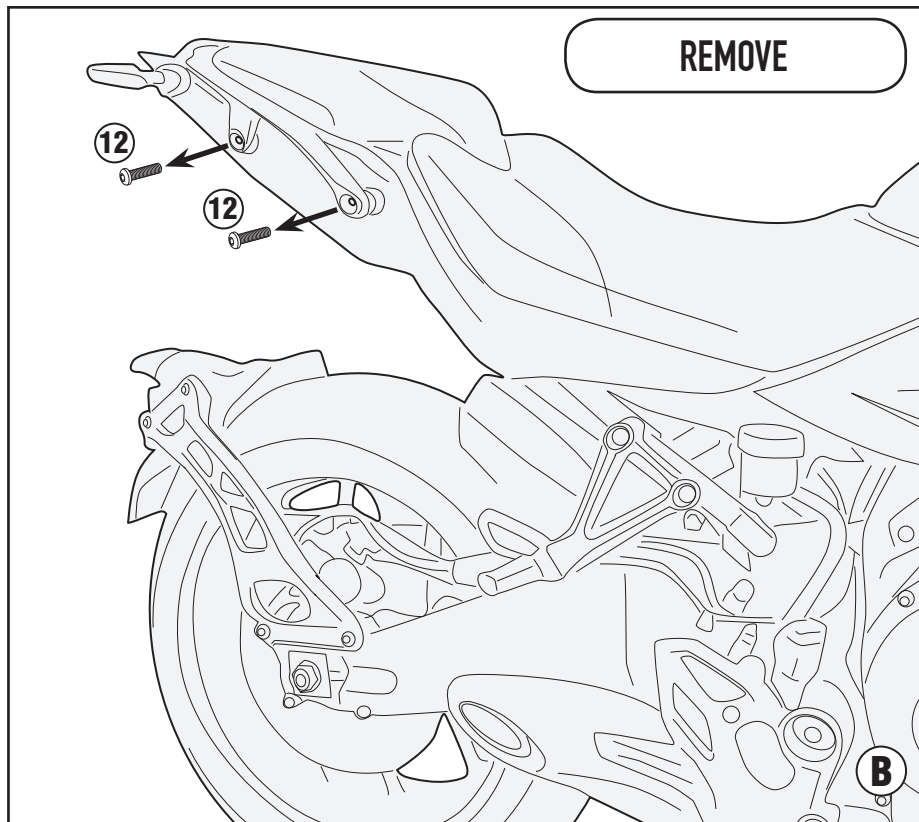

ONLY PLXR2143

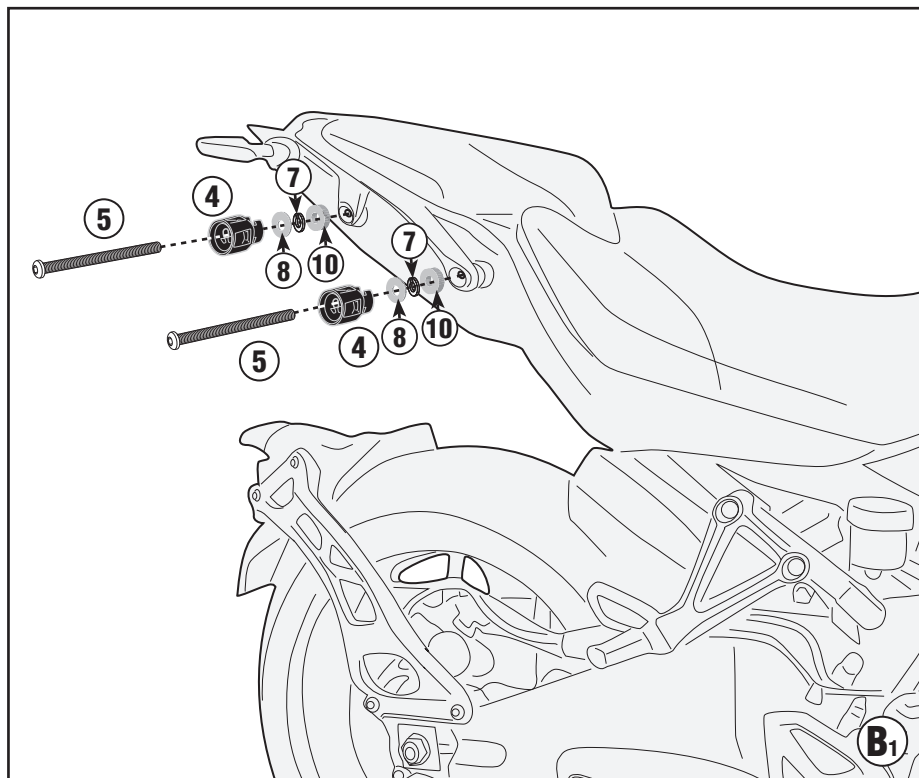

PLXR2143 - KLXR2143

PORTAVALIGIE LATERALE SPECIFICO - SPECIFIC TUBULAR SIDE-CASE HOLDER - PORTE-VALISES LATÉRAUX SPÉCIFIQUE
SPEZIFISCHES STAHLROHR-SEITENTRAEGER - PORTA MALETAS LATERALES ESPECÍFICO - TRONCO LADO ESPECÍFICO

YAMAHA NIKEN 900(2019)

SR2143+ PLXR2143

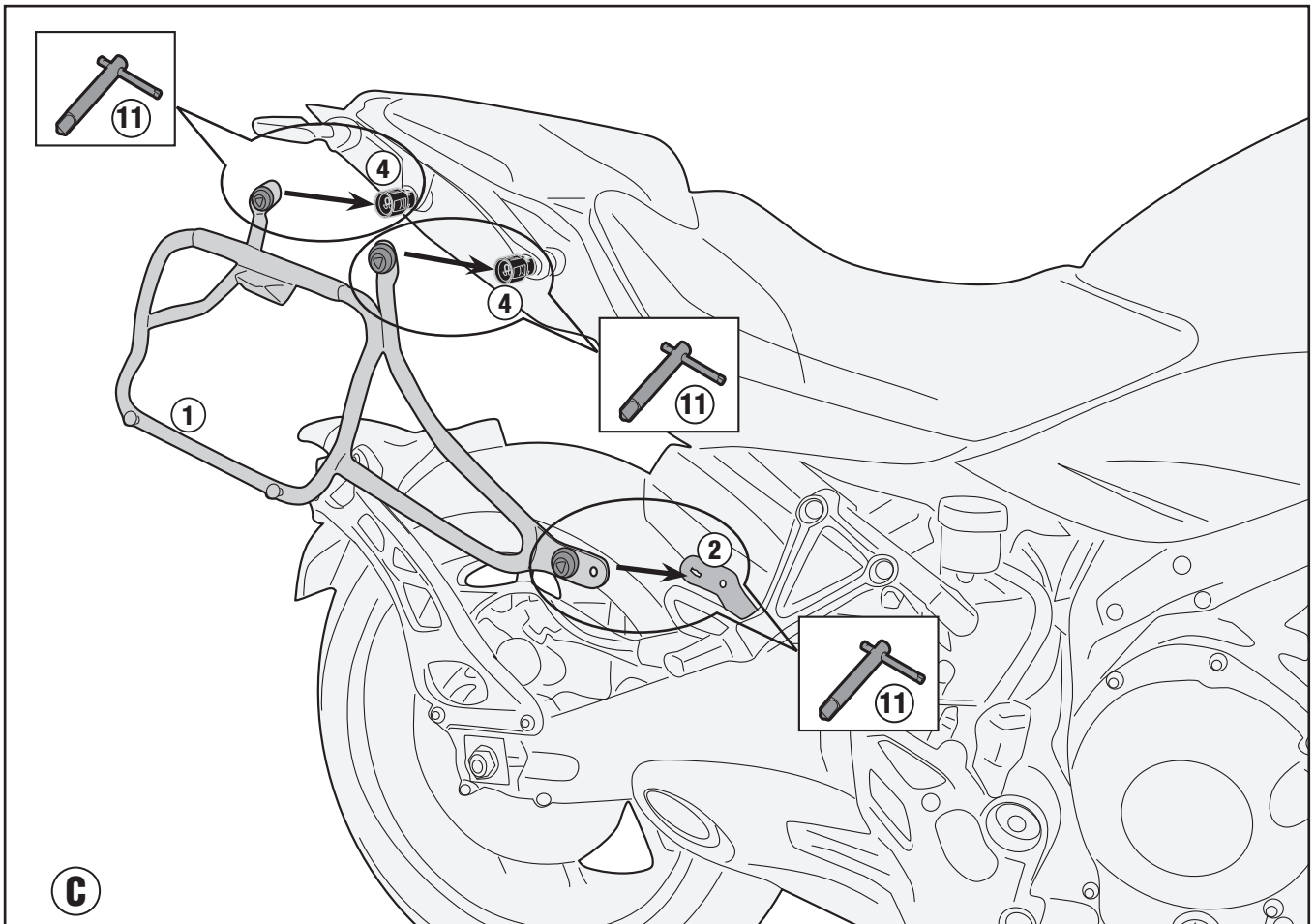
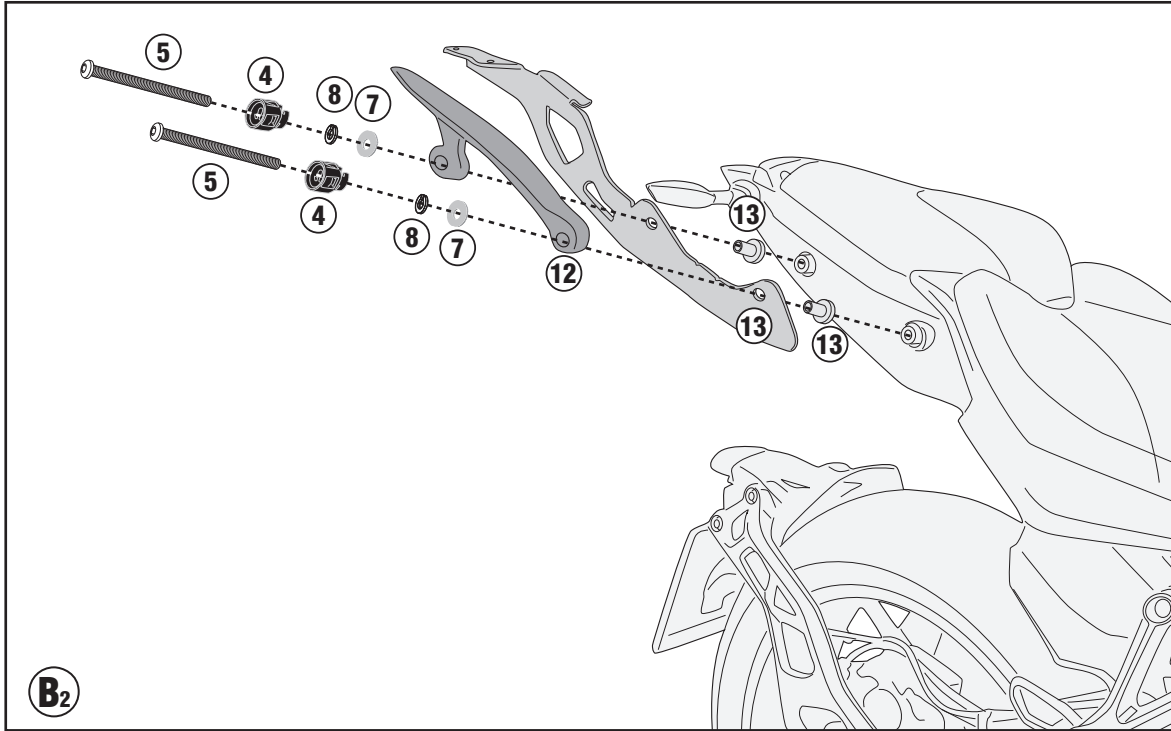

PLXR2143 - KLXR2143

PORTAVALIGIE LATERALE SPECIFICO - SPECIFIC TUBULAR SIDE-CASE HOLDER - PORTE-VALISES LATÉRAUX SPÉCIFIQUE
SPEZIFISCHES STAHLROHR-SEITENTRAEGER - PORTA MALETAS LATERALES ESPECÍFICO - TRONCO LADO ESPECÍFICO

YAMAHA NIKEN 900(2019)

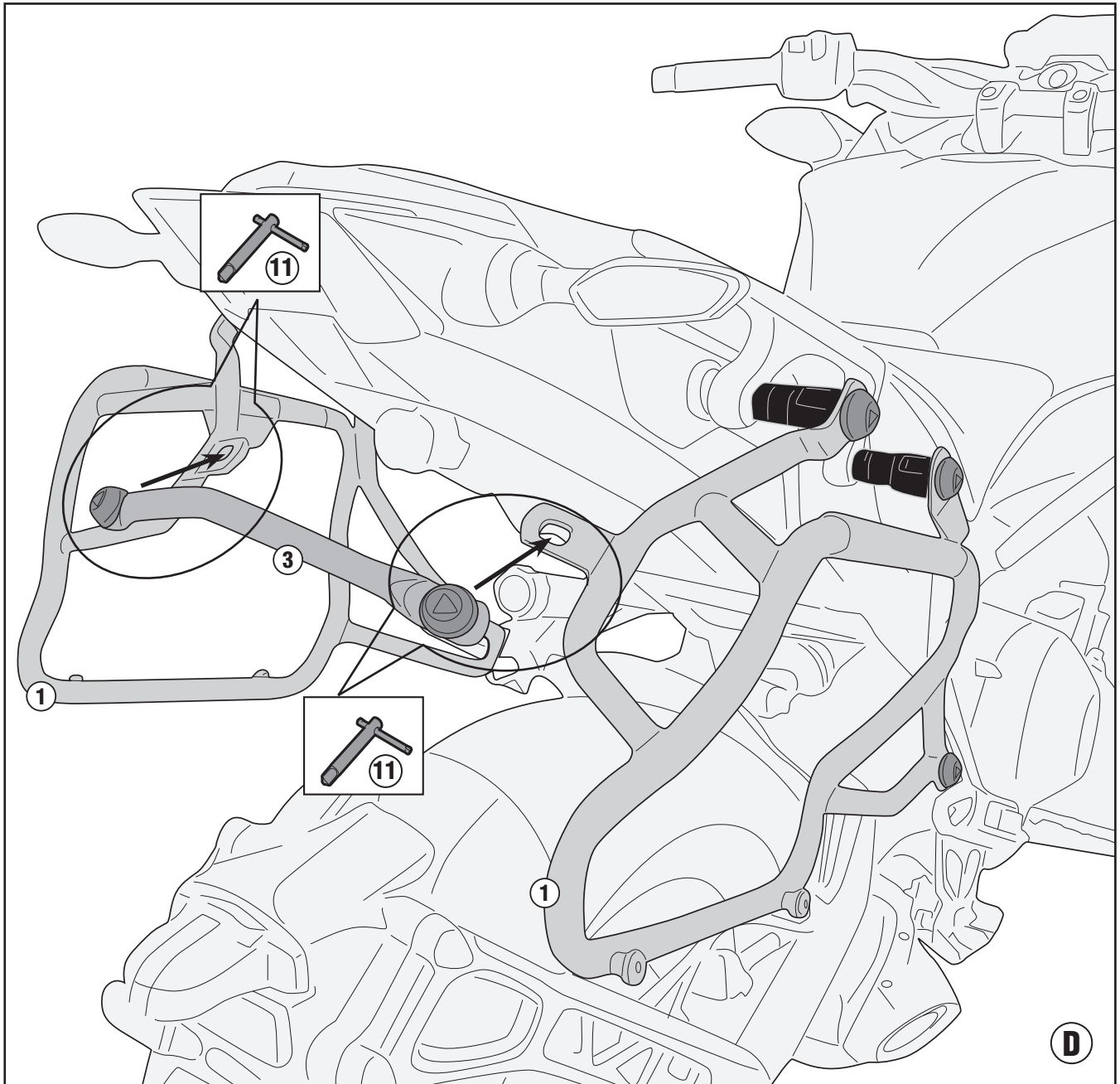

PLXR2143 - KLXR2143

PORTAVALIGIE LATERALE SPECIFICO - SPECIFIC TUBULAR SIDE-CASE HOLDER - PORTE-VALISES LATÉRAUX SPÉCIFIQUE
SPEZIFISCHES STAHLROHR-SEITENTRAEGER - PORTA MALETAS LATERALES ESPECÍFICO - TRONCO LADO ESPECÍFICO

YAMAHA NIKEN 900 (2019)

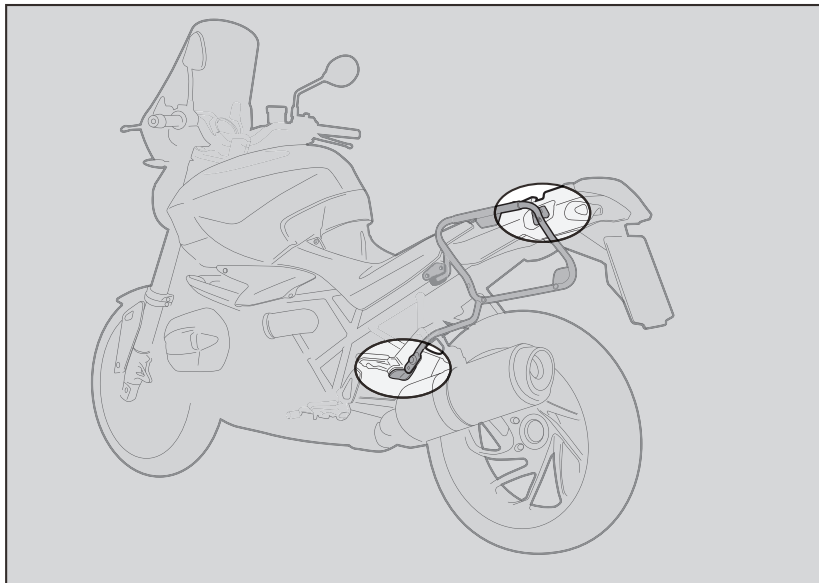

1. INSERIRE L'ATTREZZO NELLA TESTA DELLA VITE SPECIALE;
2. RUOTARE DI 1/4 DI GIRO IN SENSO ORARIO FINO A CHE LA ROTAZIONE NON TERMINA E SI AVVERTE LO SCATTO;
3. PER SMONTARE PROCEDERE IN SENSO INVERSO.

1. INSERT THE SPECIAL KEY INTO THE HEAD OF THE SCREW;
2. TURN THE KEY ¼ TURN CLOCKWISE UNTIL ROTATION STOPS AND THE SIDE CASE HOLDER IS FASTENED SECURELY TO THE FITMENT POINT;
3. IN ORDER TO DISASSEMBLE THE BRACKETRY PERFORM THE OPERATION IN REVERSE.

1. INSERER LA CLE SPECIALE DANS LA TÊTE DE LA VIS;
2. VISSER D'¼ DE TOUR DANS LE SENS HORAIRE JUSQU'AU BLOCAGE DE LA VIS POUR MONTER EN TOUTE SECURITE LE SUPPORT A SON POINT DE FIXATION;
3. POUR LE DEMONTAGE, PROCEDER EN SENSE INVERSE.

1. STECKEN SIE DAS WERKZEUG IN DEN KOPF DER SPEZIFISCHEN SCHRAUBE;
2. DREHEN SIE DIE SCHRAUBE 1 / 4 UMDREHUNG IM UHRZEIGERSINN BIS SIE BEMERKEN, DASS DIE SCHRAUBE IM BEFESTIGUNGSPUNKT EINGEKLEMMT IST;
3. FÜR DIE DEMONTAGE FOLGEN SIE DEN HINWEISE UMGEKEHRT.

1. INSERTAR LA LLAVE ESPECIAL EN LA CABEZA DEL TORNILLO
2. DAR ¼ DE VUELTA EN EL SENTIDO HORARIO HASTA QUE LLEGUE AL TOPE Y SE VEA EL TORNILLO;
3. PARA DESMONTARLO PROCEDER EN LA DIRECCIÓN CONTRARIA;

MONTAGGIO - ASSEMBLY - MONTAGE - MONTAGE - MONTAJE

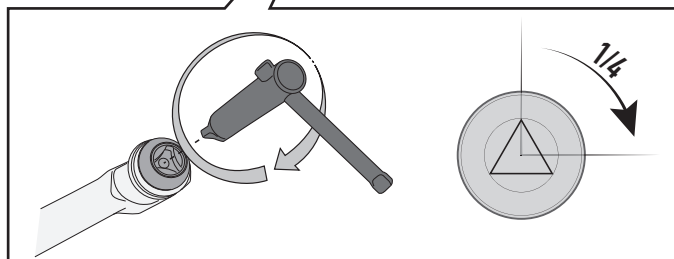
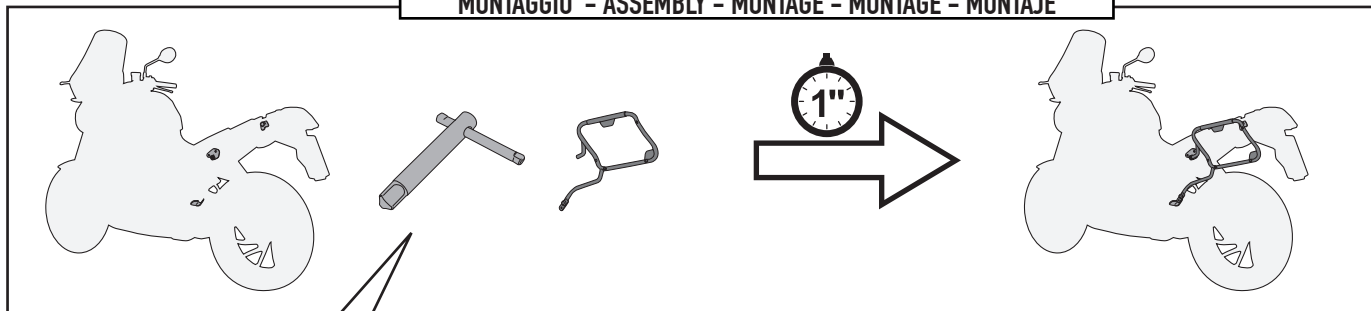

SMONTAGGIO - DISASSEMBLY - DÉMONTAGE - DEMONTAGE - DESMONTAJE

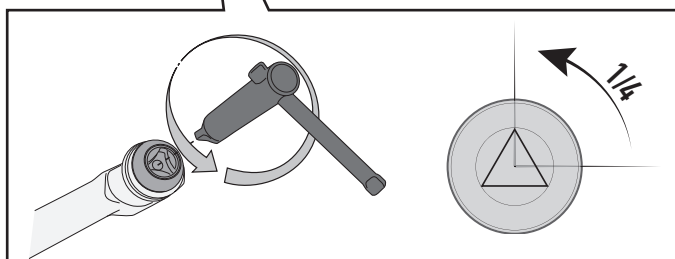
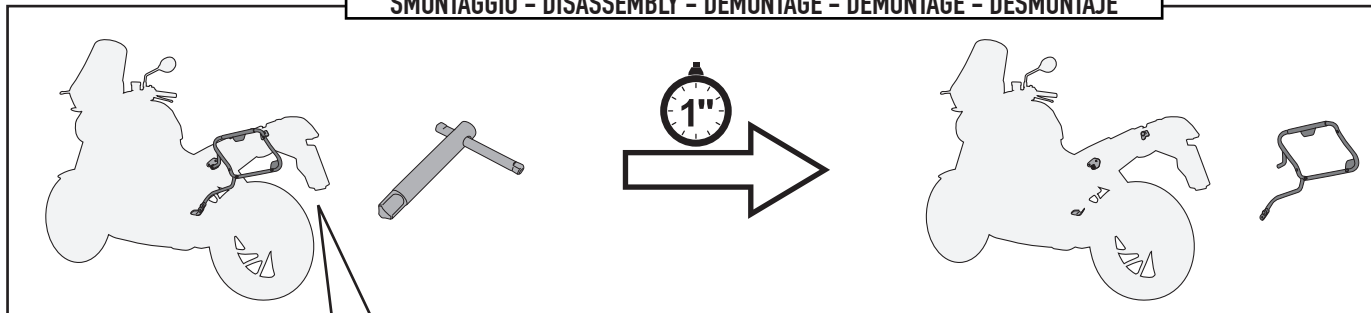

PLXR2143 - KLXR2143

PORTAVALIGIE LATERALE SPECIFICO - SPECIFIC TUBULAR SIDE-CASE HOLDER - PORTE-VALISES LATÉRAUX SPÉCIFIQUE
SPEZIFISCHES STAHLROHR-SEITENTRAEGER - PORTA MALETAS LATERALES ESPECÍFICO - TRONCO LADO ESPECÍFICO

YAMAHA NIKEN 900(2019)

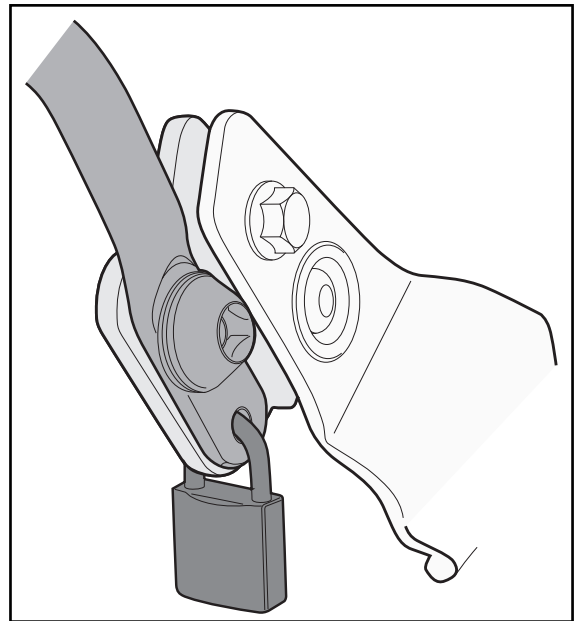
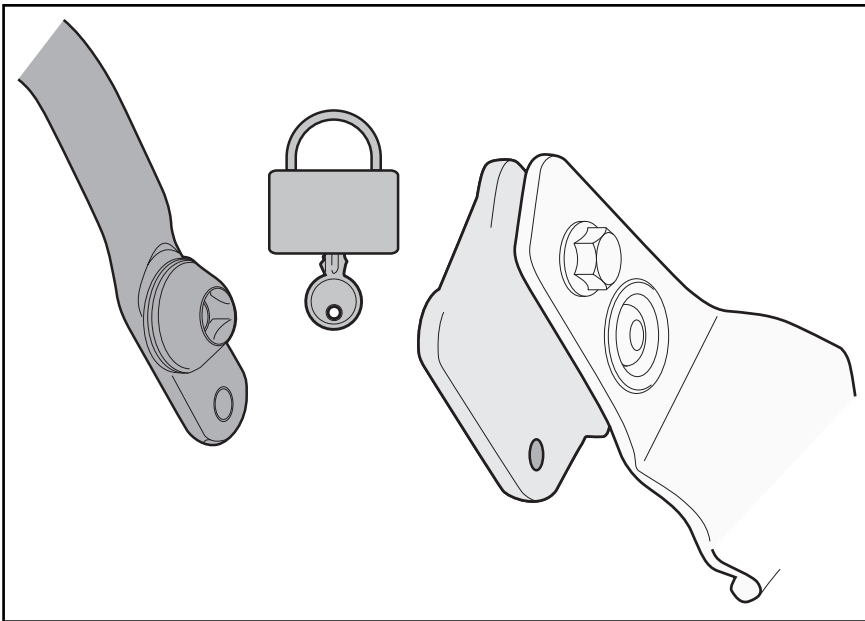
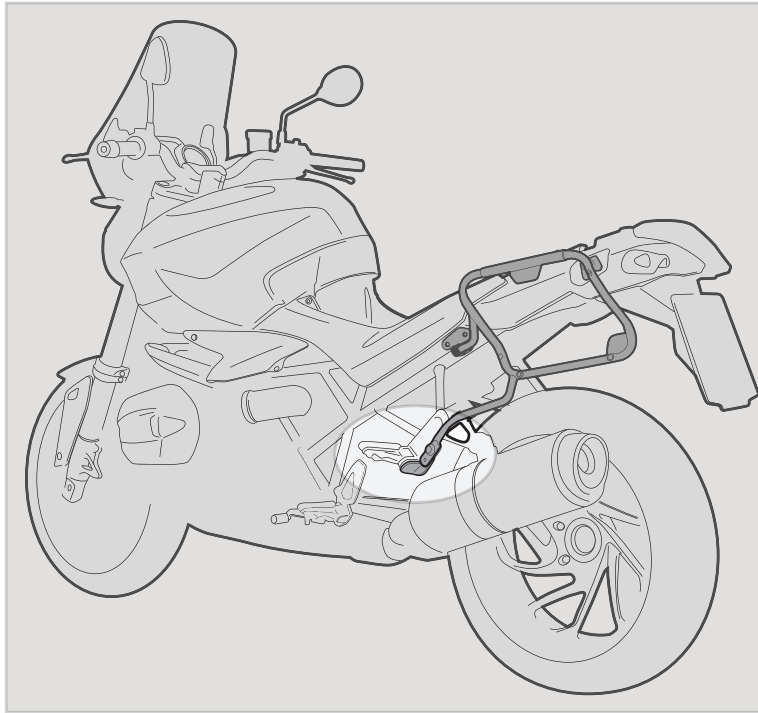

FORO DI SICUREZZA

FORO PREDISPOSTO AD ASSICURARE IL PORTAVALIGIE LATERALE ALLA MOTO (CON UN LUCCHETTO PER ESEMPIO, NON INCLUSO).

SECURITY HOLE

HOLE PLACEMENT IN ORDER TO INCREASE SECURITY OF THE TUBULAR SIDE-CASE HOLDER TO THE MOTORCYCLE (WITH A LOCK, FOR EXAMPLE, NOT INCLUDED).

TROU DE SECURITE

TROU PREDISPOSE POUR ASSURER LE PORTE-VALISE LATERAL A LA MOTO (AVEC UN CADENAS PAR EXEMPLE, NON INCLUS).

SICHERHEITSLÖCH

VORGESEHENES LOCH UM DEN SEITENKOFFER TRÄGER AN DEM FAHRZEUG ZU SICHERN (Z. B. MIT EINEM VORHÄNGESCHLOSS, NICHT ENTHALTEN);

ORIFICIO DE SEGURIDAD

ESTE ORIFICIO ESTA CREADO PARA ASEGURAR EL PORTAEQUIPAJES LATERAL A LA MOTO (POR EJEMPLO CON UN CANDADO, QUE NO ESTÁ INCLUIDO).