

ATTACCHI SPECIFICI PER - SPECIFIC FITTING KIT FOR  
 KIT DE MONTAGE SPECIFIQUE POUR - SPEZIFISCHER MONTAGEKIT FÜR  
 ANCLAJE ESPECIFICO PARA

# YAMAHA CIGNUS X 125 2007

ISTRUZIONI DI MONTAGGIO - MOUNTING INSTRUCTIONS  
 INSTRUCTIONS DE MONTAGE - BAUANLEITUNG - INSTRUCCIONES DE MONTAJE

1



**SUPPORTO**  
 SUPPORT  
 SUPPORT  
 HALTERUNG  
 SOPORTE

**Q.TY n.2(Dx-Sx)**

2



**PIASTRINA**  
 LITTLE PLATE  
 PETITE PLAQUE  
 PLAETTCHEN  
 PLAQUETA

**Q.TY n.2(Dx-Sx)**

3



**FASCETTA A "T"**  
 Z870N  
 "T" CLAMP  
 COLLIER A "T"  
 "T" SCHELLE  
 ABRAZADERA A "T"

**Q.TY n.4**

4



**BOCCOLA DI RITENZIONE**  
 VETRO z871N  
 PLASTIC BUSH  
 DOUILLE PLASTIQUE  
 PLASTIK BUCHSE  
 CASQUILLO

**Q.TY n.4**

5

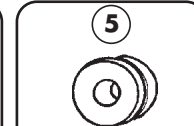

**GOMMINO Z268**  
 Z268 FAIRLEADER  
 CHAUMARD Z268  
 GUMMI Z268  
 GOMA Z268

**Q.TY n.4**

6

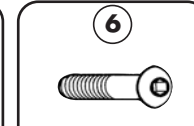

**VITE TBEI M6x25 nera**  
 SCREW M6x25 black  
 VIS M6x25 noire  
 SCHRAUBE M6x25 schwarz  
 TORNILLO M6x25 negra

**Q.TY n.4**

7

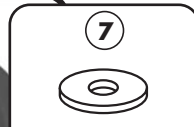

**RONDELLA Ø13,5x25**  
**SPESSORE 2mm**  
 WASHER Ø13,5x25mm  
 RONDELLE Ø13,5x25mm  
 SCHEIBE Ø13,5x25mm  
 ARANDELA Ø13,5x25mm

**Q.TY n.2**

8



**RONDELLA IN GOMMA**  
**Ø15X25 SPESSORE 4**  
 RUBBER WASHER  
 RONDELLE EN GOMME  
 GUMMISCHIBE  
 ARANDELA DE GOMA

**Q.TY n.3**

9



**RONDELLA IN GOMMA**  
**Ø16X33 SPESSORE 1**  
 RUBBER WASHER  
 RONDELLE EN GOMME  
 GUMMISCHIBE  
 ARANDELA DE GOMA

**Q.TY n.2**

10

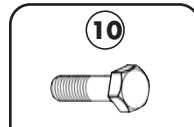

**VITE TE M8x55mm**  
 SCREW M8x55mm  
 VIS M8x55mm  
 SCHRAUBE M8x55mm  
 TORNILLO M8x55mm

**Q.TY n.2**

11

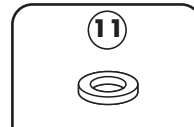

**RONDELLA Ø8mm**  
 WASHER Ø8mm  
 RONDELLE Ø8mm  
 SCHEIBE Ø8mm  
 ARANDELA Ø8mm

**Q.TY n.2**

12



**COMPONENTI ORIGINALI**  
 ORIGINAL PARTS  
 PARTIES ORIGINALES  
 ORIGINAL BAUTEILE  
 COMPONENTES ORIGINALES

**Q.TY n.-**

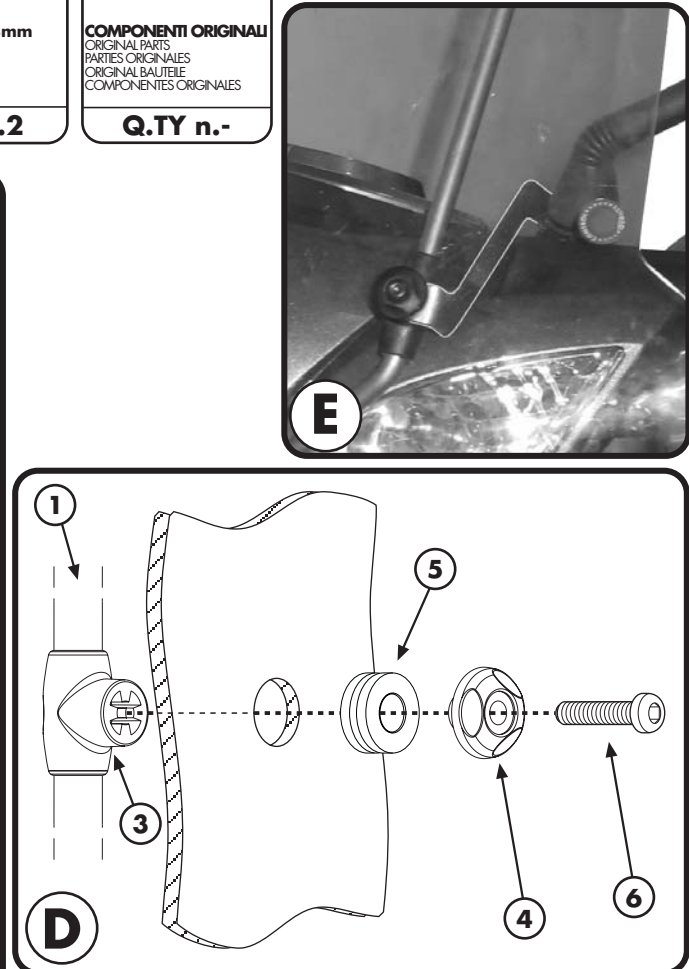
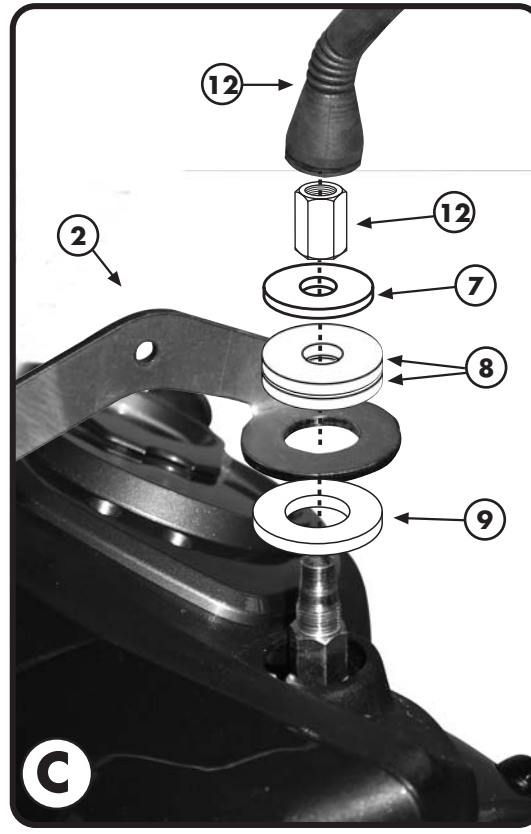
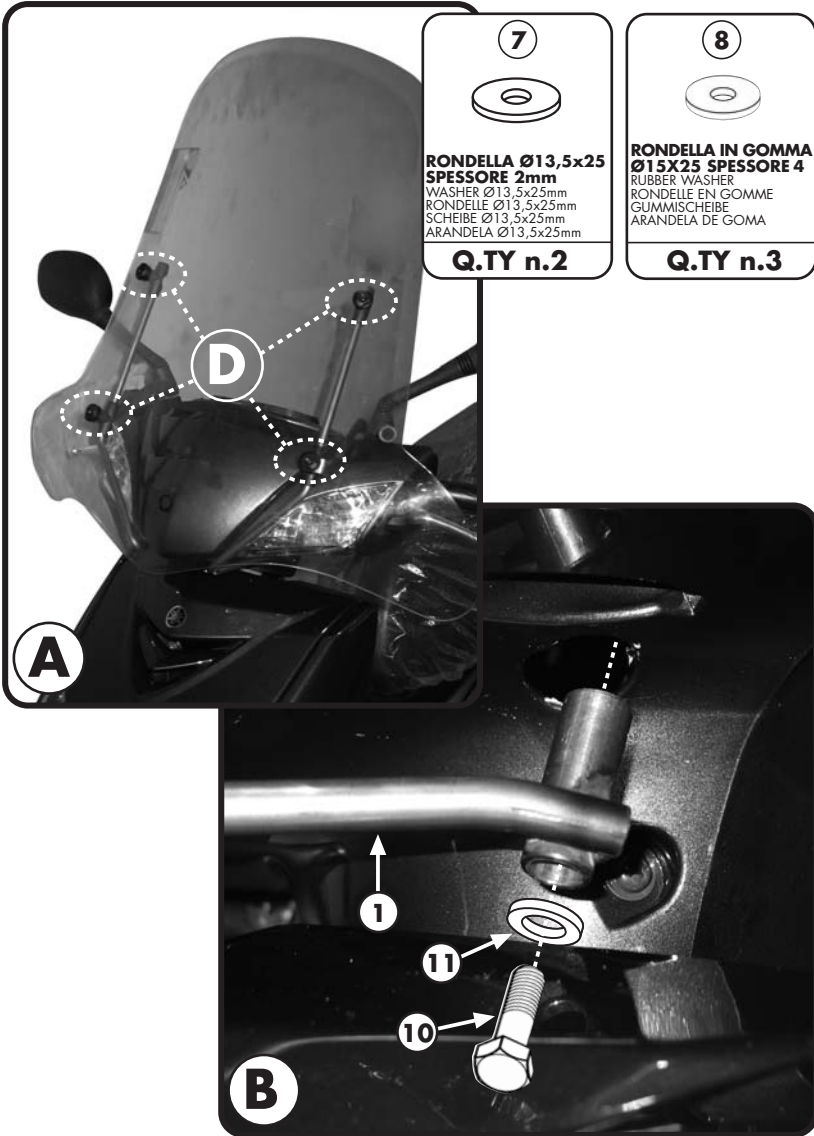

ATTACCHI SPECIFICI PER - SPECIFIC FITTING KIT FOR  
KIT DE MONTAGE SPECIFIQUE POUR - SPEZIFISCHER MONTAGEKIT FÜR  
ANCLAJE ESPECIFICO PARA

# YAMAHA CIGNUS X 125 2007

ISTRUZIONI DI MONTAGGIO - MOUNTING INSTRUCTIONS  
INSTRUCTIONS DE MONTAGE - BAUANLEITUNG - INSTRUCCIONES DE MONTAJE

## I ISTRUZIONI DI MONTAGGIO

1. RIMUOVERE I TAPPI COPRIFORO PRESENTI SULLA PARTE INFERIORE DELLA CARENATURA DEL MANUBRIO INTERESSATE NEL MONTAGGIO DELLE ASTE SUPPORTO N°1, FOTOGRAFIA B;
2. QUINDI ESEGUIRE IL MONTAGGIO INDICATO IN FOTOGRAFIA B E C FACENDO ATTENZIONE CHE NEL MONTAGGIO SUL LATO DESTRO LA RONDELLA N°8 VA UTILIZZATA IN QUANTITÀ 1 PEZZO MENTRE SUL LATO SINISTRO VA UTILIZZATA IN QUANTITÀ 2 PEZZI;
3. MONTARE IL PARABREZZA (NON INCLUSO), IMMAGINE D;
4. ULTIMARE IL MONTAGGIO CONTROLLANDO CHE TUTTE LE VITI SIANO SERRATE BENE.

## GB MOUNTING INSTRUCTIONS

1. REMOVE THE HOLE CAPS PLACED IN THE LOWER PART OF THE FAIRING OF THE HANDLEBAR, SO AS TO ENABLE THE FIXING OF THE SUPPORT BARS N°1, PICTURE B;
2. FOLLOW THE MOUNTING PROCEDURE INDICATED IN THE PICTURES B AND C PAYING ATTENTION THAT YOU SHOULD USE 1 PC OF THE RUBBER WASHER N°1 FOR THE RIGHT SIDE AND 2 PCS OF THE SAME FOR THE LEFT SIDE;
3. MOUNT THE WIND-SCREEN (NOT INCLUDED) AS SHOWN IN PICTURE D;
4. LASTLY CHECK THAT ALL SCREWS HAVE BEEN TIGHTENED.

## F INSTRUCTIONS DE MONTAGE

1. ENLEVER LES CACHES SE TROUVANT SUR LA PARTIE INFÉRIEURE DU CARENAGE DU GUIDON, CONCERNES PAR LE MONTAGE DES SUPPORTS N.1, PHOTO B ;
2. PROCÉDER AU MONTAGE INDIQUE EN PHOTO B ET C FAIRE ATTENTION A NE METTRE QU'UNE RONDELLE N°8 DU CÔTÉ DROIT ET DEUX DU CÔTÉ GAUCHE ;
3. MONTER LE PARE-BRISE (NON INCLUS) , PHOTO D ;
4. TERMINER LE MONTAGE EN CONTROLANT LE BON SERRAGE DE TOUTES LES VIS.

## D BAUANLEITUNG

1. ENTFERNEN SIE DIE LOCHABDECKUNGEN AUS DEM UNTEREN TEIL DER LENKERVERKLEIDUNG, UM DIE MONTAGE DER HALTERUNGSTANGEN NR. 1 ZU ERMO'F6GLICHEN, BILD B;
2. FU'FCHREN SIE DIE MONTAGE DER BILDER B UND C DURCH, PASSEN SIE AUF, DASS BEI DER MONTAGE DER RECHTEN SEITE 1 STK. DER GUMMISCHEIBE NR. 8 VERWENDET WIRD, FU'FCR DIE LINKE SEITE BRAUCHEN SIE DAGEGEN 2 STK.
3. MONTIEREN SIE DAS WINDSCHILD (NICHT VORHANDEN), BILD D;
4. ZULETZT U'FCBERPRU'FCFEN SIE, DASS ALLE SCHRAUBEN FESTGEZOGEN WURDEN.

## ES

## INSTRUCCIONES DE MONTAJE

1. QUITAR LOS TAPONES DE LOS TORNILLOS QUE SE ENCUENTRAN EN LA PARTE INFERIOR DEL CARENADO DEL MANILLAR . DESPUÉS MONTAR LOS ANCLAJES SOPORTE N°1 FOTOGRAFIA B
2. EFECTUAR EL MONTAJE INDICADO EN LAS FOTOGRAFÍAS "B" Y "C" TENIENDO CUIDADO EN EL MONTAJE. AL LADO DERECHO SE USA SOLO UNA ARANDELA N° 8 MIENTRAS QUE AL LADO IZQUIERDO SE UTILIZAN 2 ARANDELAS;
3. MONTAR EL PARABRISAS (NO INCLUIDO) IMAGEN "D"
4. TERMINAR EL MONTAJE VERIFICANDO QUE TODOS LOS TORNILLOS ESTEN BIEN CERRADOS.